

Varenummer: 40550400311240
 Beskrivelse: Tandhjulsgear S401P-3,1-P100B5

Mål

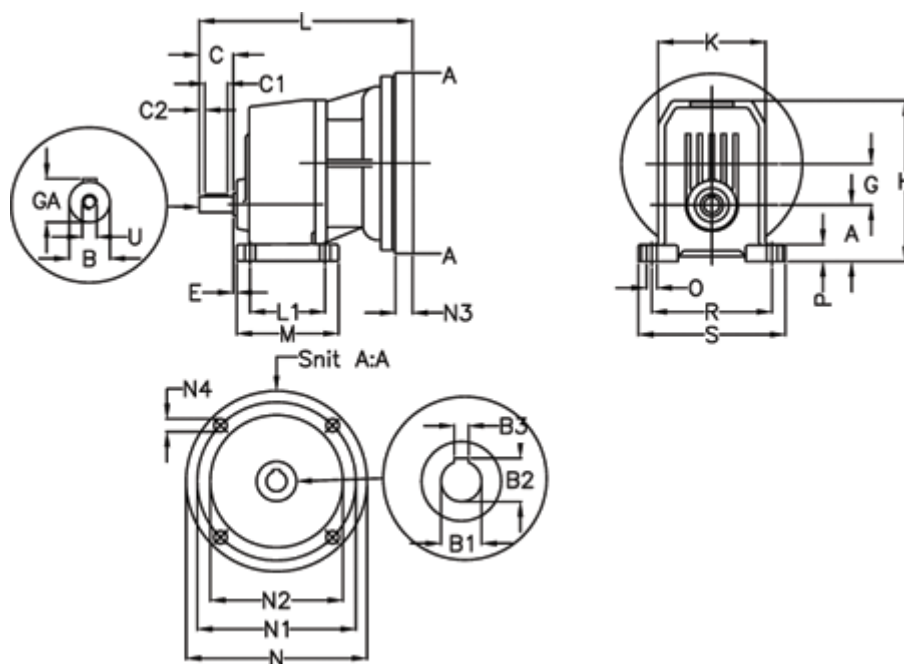

A = 70	E = 23.0	M = 165.0	R = 180
B = 28	F = 8x7x50	N = 250	S = 215
B1 = 28	G = 61.7	N1 = 215	U = M8
B2 = 31.3	GA = 31.0	N2 = 180	
B3 = 8	H = 224.5	N3 = -	
C = 60	K = 155	N4 = M12x16	
C1 = 50	L = 304	O = 14	
C2 = 5	L1 = 125.0	P = 21.0	